

Strategic Network Level Mapping of Underground Assets using Ground Penetrating Radar

Mark BELL, Australia

Key words: GPR, ground penetrating radar, frequency, array, utilities, mapping, LiDAR

SUMMARY

The commercial, safety and community benefits for using Ground Penetrating Radar (GPR) in the detection of underground assets, in particular utilities, is well proven. Currently most GPR surveys are typically carried out by hand pushed units using either single or dual frequency systems to confirm and/or locate underground assets. Once located, asset locations are marked using spray paint, the GPR images are saved for reporting and sometimes locations are mapped using GPS or other means for further use in CAD or GIS. These surveys are typically independently commissioned to contractors by utilities organisations with information rarely shared between organisations after survey completion.

Advanced development of GPR systems now allows for rapid full 3D capture of underground assets using arrays of multi-frequency, multi-polarized antenna GPR towed by vehicles. This rapid capture capability is bringing to the table a case for a more coordinated capture of underground asset location across utility organisations for centralised and coordinated management and improvement of the efficiency of construction activities.

The vehicle based GPR underground asset capture capability is towable and compliments the push for above ground asset capture using mobile 3D laser scanning technologies.

SUMMARY

The komersial, keamanan dan keuntungan bagi masyarakat untuk menggunakan Ground Penetrating Radar (GPR) dalam mendeteksi aset bawah tanah , dalam utilitas tertentu , terbukti dengan baik . Saat ini sebagian besar survei GPR biasanya dilakukan dengan tangan unit mendorong menggunakan sistem frekuensi baik tunggal atau ganda untuk mengkonfirmasi dan / atau mencari aset bawah tanah . Setelah terletak , lokasi aset ditandai dengan cat semprot , gambar GPR disimpan untuk melaporkan dan kadang-kadang lokasi dipetakan menggunakan GPS atau cara lain untuk digunakan lebih lanjut dalam CAD atau GIS . Survei ini biasanya independen ditugaskan kepada kontraktor oleh utilitas organisasi dengan informasi jarang dibagi antara organisasi setelah survei selesai .

Pengembangan lanjutan dari sistem GPR sekarang memungkinkan untuk cepat menangkap 3D penuh dari aset bawah tanah menggunakan array multi - frekuensi , multi - terpolarisasi antena GPR diderek oleh kendaraan . Kemampuan ini cepat menangkap membawa ke meja kasus untuk menangkap lebih terkoordinasi lokasi aset bawah tanah di seluruh organisasi utilitas untuk pengelolaan terpusat dan terkoordinasi dan peningkatan efisiensi kegiatan

konstruksi .

GPR kemampuan menangkap aset tanah berbasis kendaraan towable dan pujian atas dorongan
untuk menangkap aset tanah menggunakan ponsel teknologi 3D LIDAR

Strategic Network Level Mapping of Underground Assets using Ground Penetrating Radar

Mark BELL, Australia

1. INTRODUCTION

Ground penetrating radar (commonly called GPR) is a high resolution electromagnetic technique designed primarily to investigate the shallow subsurface of the earth and uses the principal of scattering of high frequency electromagnetic waves (typically from 10 MHz to 3,000 MHz) to locate buried objects (Daniels, 2000).

For over 30 years GPR has been used to detect buried utilities under the ground and this still remains one of the most widely used applications for the technique. Ground Penetrating Radar is one of the highest resolution geophysical techniques available and this makes it ideal to position underground objects located in complex geometries, for example, underneath urban environments. One of GPR's features is that it can be used to detect any material buried within the shallow subsurface providing there is a contrast between the electromagnetic properties of the object and the surrounding material within which it is buried. As utilities are man-made from a variety of materials including plastics and metals and are typically linear and cylindrical in nature, this makes them easily recognizable targets for GPR.

These features make GPR one of the chosen tools for utility locators which they combine with other techniques such as EMI (electromagnetic induction), vacuum excavation and trenchless technology to optimise the efficiency of excavations and provide a total solution for their customers.

This application for GPR has lead to the development of many specialised systems designed specifically for on-site utility location. Figure 1 shows an example of one of these systems designed by IDS, the Opera Duo, which has many useful features such as automatic delivery of CAD drawings, GPS tracking with Google Earth and dual frequency antennas for finding both deep and shallow buried utilities.

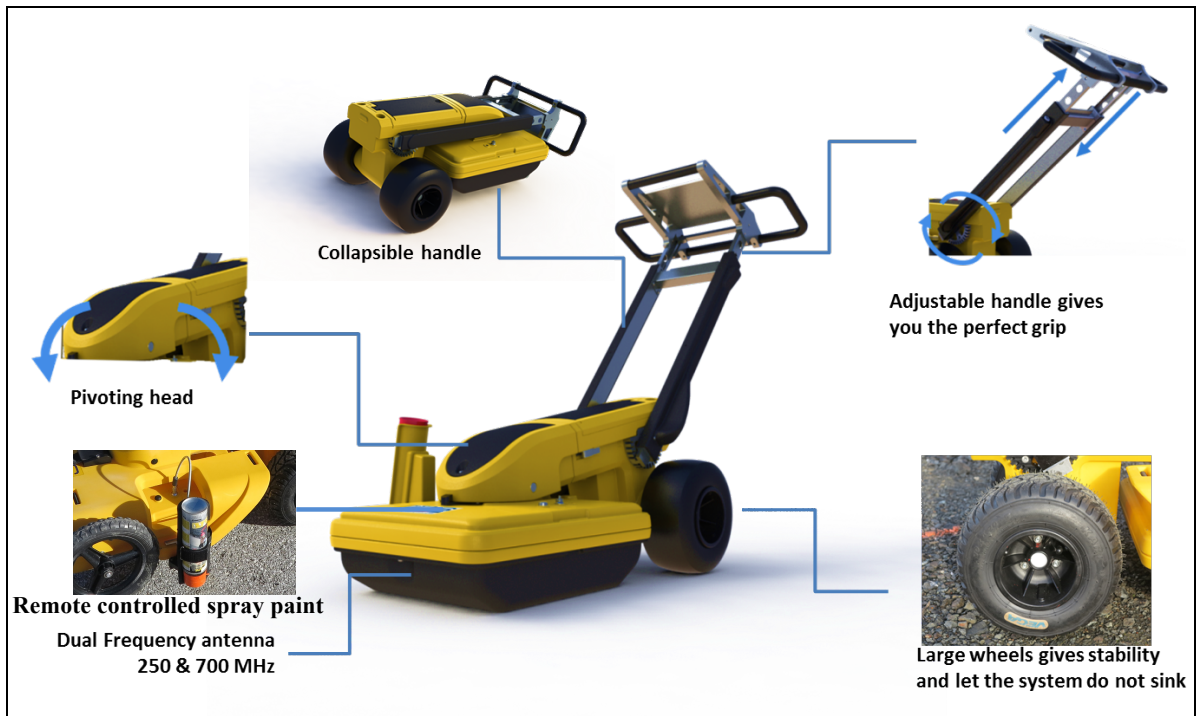

Opera Duo main features

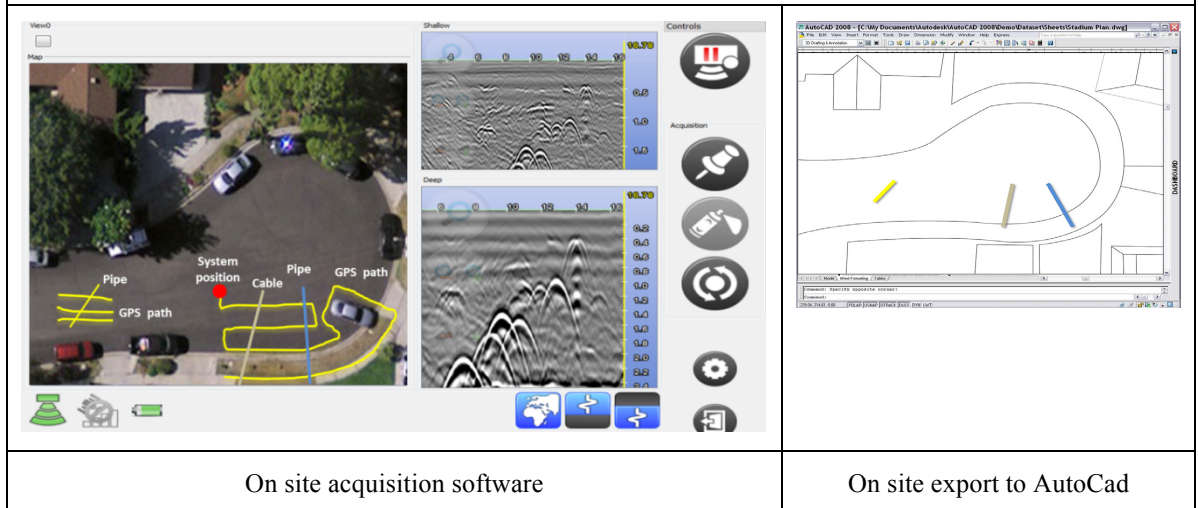

Figure 1 shows the Opera Duo system features and functionality.

Typically, these mark in-field systems are hand pushed over an area with utilities showing up as hyperbolic features in a 2-dimensional cross section image of the subsurface (See Figure 2).

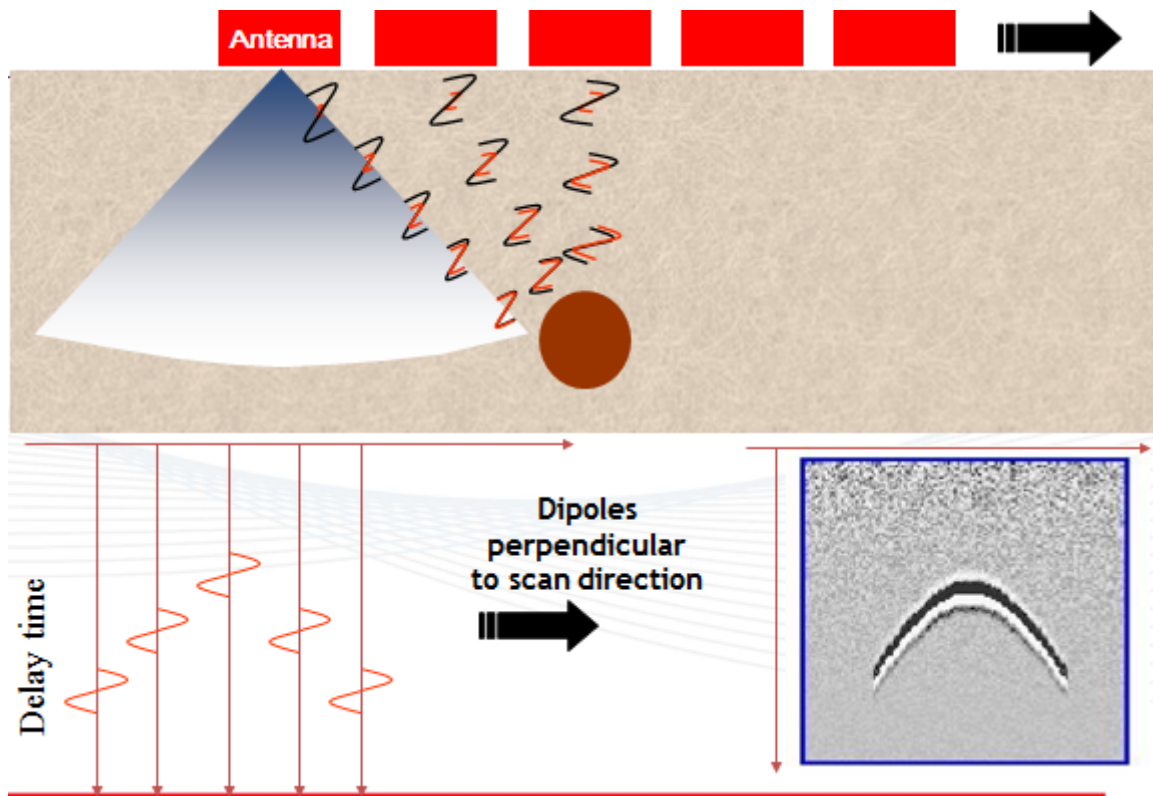

Figure 2 Radargrams are displayed as Distance (x-axis) versus Time (y-axis) plots and as such when an antenna approaches an object like a pipe, the time for the signal to transmit, reach the pipe and return to the receiving antenna is called the two way time. This reduces as the antenna approaches the pipe and increases when it moves away from the pipe. Hence, hyperbolic features are seen in the radargram.

Once a utility is located, the ground is typically marked with paint to verify its location. This process is repeated over the survey area until all possible utilities are marked on site and the earthmoving contractor can then safely excavate the ground.

Presently, GPR information marked on site in Australia is generally not collected or stored on a database and companies that do store the information, do not share this information publicly. This means that once an area is surveyed, and the paint marks wash away, the information is lost. This results in some areas being surveyed multiple times at considerable economic cost. Added to this, is the social and environmental costs to the community, where roads may need to be closed multiple times each year causing increased traffic congestion, noise, pollution, waste of materials and general frustration.

In Australia, Dial Before You Dig (DBYD) provides a free service which links asset owners to customers which include utility locating and construction companies, by providing information on the location of utilities underground. Whilst this is an excellent service, the information is often “as planned” and not “as built” and has variable quality and accuracy. Also, there is currently no requirement for utility locating companies and surveyors to update information once utilities are exposed by vacuum excavation and their position correctly and accurately identified, hence the database of utilities remains generally unverified with variable

levels of accuracy.

In June 2013, a new national standard for Subsurface Utility Information (SUI), Australian Standard AS 5488-2013, was derived partially from the Subsurface Utility Engineering (SUE) originally introduced in the United States. This standard combines geophysics, surveying and civil engineering to provide accurate identification and mapping of underground assets. Its aim is to provide utility owners, operators and locators with a framework for the consistent classification of information concerning subsurface utilities whilst improving safety, reducing delays, reducing damage to utilities and protecting the environment (Committee IT-036, 2013).

With the gradual implementation of this new standard and the possibility of more regulation being a very real possibility in the future, Australian utility locating companies and asset owners are beginning to see the benefits of collection and maintenance of reliable subsurface utility databases. Whilst mark on site work using handheld trolley GPR systems will always be a necessary tool for utility locators, there is a growing shift toward the collection of data over large areas using array and massive array GPR systems. This paper highlights advances and advantages of using GPR array systems to map utilities at a network level and the benefits in combining this information with LiDAR to obtain a more complete understanding of the survey area.

2. THE USE OF ARRAY GPR SYSTEMS FOR NETWORK LEVEL MAPPING

Array GPR systems can be used to map areas quickly and allow 3D visualisation of the subsurface. Arrays of antennas allow utility signatures (hyperbolas) to be traced across each antenna and these hyperbola signatures typically line up across the array to show the orientation of the pipe. Arrays therefore make it easier to determine the difference between say a buried rock, which may also produce a single hyperbola signature, and an actual buried utility and make interpretation easier and more accurate.

GPR arrays also enable faster data collection as few array scans are needed instead of many single antenna passes. For example, a 4 antenna array can collect data 4 times as fast as a 1 antenna system. A further benefit of using an array system, is the possibility to survey areas using an orthogonal grid, so that advanced signal processing techniques can be used to improve the data quality of the final deliverable dataset by allowing image-processing filters such as line finding algorithms techniques to be used to enhance pipe like features (Manacorda et al, 2009).

The IDS RIS Hi-Mod system (See Figure 3) is an array radar system tailored to map both deep and shallow buried assets by using an innovative dual frequency antenna array and advanced data analysis software. The RIS Hi-Mod array is GPS and total station compatible and can be configured with 1, 2, 3 or 4 antennas and is available in either 200-600 MHz or 400-900MHz configurations. By using the full configuration of 4 antennas, a width of 2 m is covered in a single pass with a distance between profiles of less than 0.5 m (Manacorda et al, 2009).

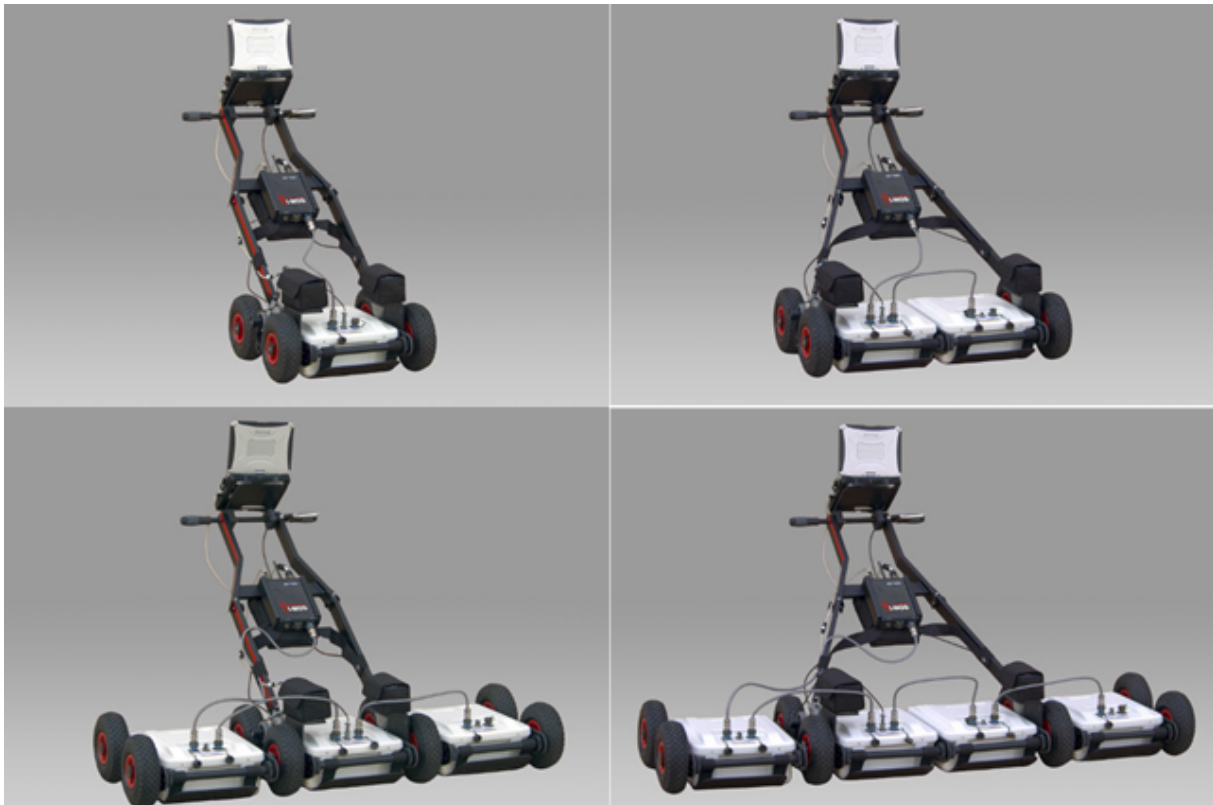

Figure 3 shows the RIS Hi-Mod with all 4 configurations (1, 2, 3 and 4 antenna)

The IDS Stream (Subsurface Tomographic Radar Equipment for Assets Mapping) EM GPR system is a dual-frequency dual-polarized massive array developed to dramatically increase productivity when collecting underground utility data (See Figures 4 and 5). It allows all utilities to be identified in one pass due to its dual polarised, dual frequency array and data can be collected at speeds of up to 18km/hr so that road closures are not required.

The two front arrays are 200MHz massive arrays called DML arrays (Detect Main Line) which have a vertical polarisation designed to detect main line pipes parallel to the direction of travel. This frequency has been selected for main line pipes as in almost all cases, main line pipes are not less than 20 cm deep and so will be detectable with the 200MHz antennas which only have a 12.5cm blind zone at the surface. (Simi et al, 2010)

The IDS Stream (Subsurface Tomographic Radar Equipment for Assets Mapping) EM GPR system is a dual-frequency dual-polarized massive array developed to dramatically increase productivity when collecting underground utility data (See Figures 4 and 5). It allows all utilities to be identified in one pass due to its dual polarised, dual frequency array and data can be collected at speeds of up to 18km/hr so that road closures are not required.

The two front arrays are 200MHz massive arrays called DML arrays (Detect Main Line) which have a vertical polarisation designed to detect main line pipes parallel to the direction of travel. This frequency has been selected for main line pipes as in almost all cases, main line pipes are not less than 20 cm deep and so will be detectable with the 200MHz antennas which

only have a 12.5cm blind zone at the surface. (Simi et al, 2010)

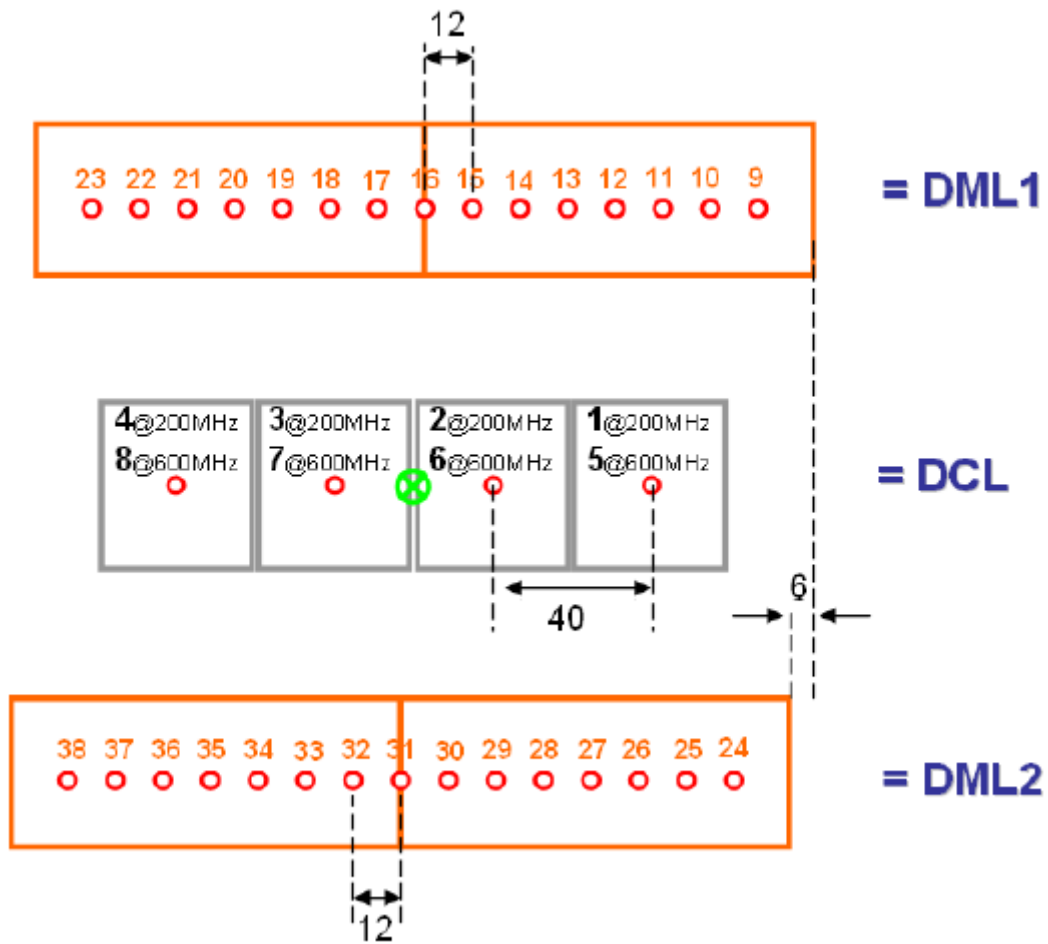

Figure 4 shows a detailed overview of the array configuration



Figure 5 shows the Stream EM system towed by a survey vehicle

The central array is called the DCL (Detect Connection Line) array and is horizontally polarised to detect connection pipes transverse to the main line and the direction of travel. The dual frequency (200-600MHz) array allows for detection of both shallow (600MHz) and deeper (200MHz) junctions to the main lines.

Another DML is added to the rear of the array with an offset of exactly 6 cm with respect to the front DML in order to halve the sampling step and ensure detection of mainline pipes in all soil conditions. This ensures a sampling step of 6cm in all directions for the 200MHz antennas. The 600 MHz antennas have a sampling step of 3cm meaning that the system has been specifically designed to provide the best possible coverage of the surveyed area whilst respecting Nyquist principles by not oversampling the EM waves generated by the antennas (Simi et al, 2010)

The whole system acquires 38 channels, 8 from the central DCL array and 30 coming from the two DML arrays which are each 15 channels. The array is GPS and total station compatible.

3. ADVANCES IN GPR PROCESSING AND INTERPRETATION SOFTWARE

The GRED HD3 high definition post processing software has been developed by I.D.S. Ingegneria dei Sistemi S.p.A and is dedicated to the visualization of GPR data acquired with all IDS GPR systems. The software uses powerful 2D and 3D processing algorithms to provide the cleanest data possible for interpretation and visualization in 2 and 3 dimensions. The software is designed to integrate seamlessly with CAD and GIS and is fully compatible with GPS or total station data integrated into the GPR data during data acquisition. The software provides 4 simultaneous viewing data windows, called cuts, which are categorised as follows and can be seen in Figure 6.

- Cut 1, XY planes (Tomography – plan view slices);
- Cut 2, YZ planes (virtual T-scan);
- Cut 3, XZ planes (L-scan);
- 3D, XYZ view.

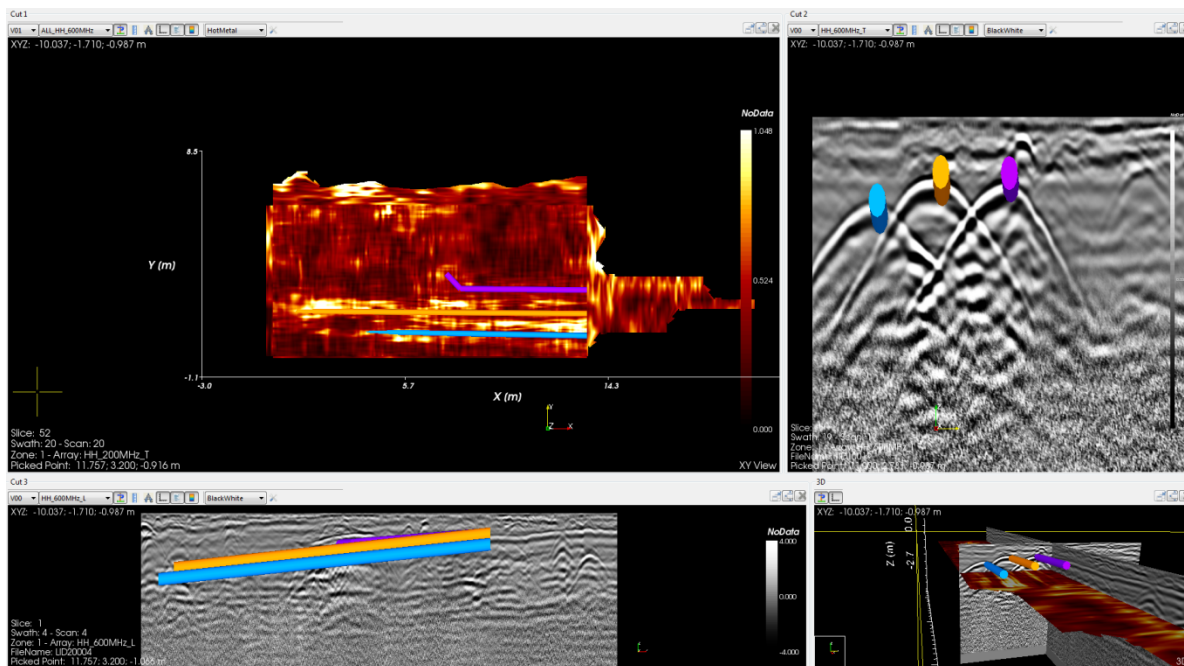

Figure 6 shows the 4 viewing windows of the GRED HD3 software

The software contains sophisticated editing features for GPS and total station data which can be set to only use positioning information of a known and preferred accuracy. The user is also able to navigate through and pick the location of utilities in any of the viewing windows in real time as the mouse cursor position, and entire dataset within each window, is completely georeferenced. When this is completed, all features are automatically exported to AutoCad via an IDS AutoCad plugin.

4. COORDINATED CAPTURE OF ABOVE AND BELOW GROUND ASSETS

Presently there are many companies currently undertaking LiDAR (light detection and Ranging) capture of city assets and there is an increased effort going into mapping all above ground assets globally. LiDAR technology simply measures the time it takes light to bounce off an object and since the speed of light is known the distance to the object can be determined. LiDAR units can now fire pulses of light much more rapidly than even 2 years ago, collecting up to 1.2 million points per second at accuracies of approximately 5mm. (Fernando, 2014) Even though the technology has been around since the 1960's it is only in the past few years that it has become both less expensive and more accurate. Google and Nokia are two of many companies currently spending large sums of money to ensure that they are the first to map the entire globe using vehicle based LiDAR.

With this revolution upon us, there is an enhanced case for the collection of LiDAR and GPR information in one pass. Collection of both sets of information gives a context to the GPR information which can assist with interpretation by mapping above ground features such as fire hydrants, gas and telephone line markers and electricity substations. By combining the above and below ground information into one CAD drawing, the interpreter is able to check the pipe positions picked in the GPR data with the above ground infrastructure mapped with

LiDAR. There are several benefits of this methodology including:

- A higher level of accuracy in the interpretation of GPR data;
- An increase in productivity by providing above ground context to the data;
- Collecting both datasets in the same pass reduces costs and increases productivity;
- Improved levels of classification of underground assets by aligning with above ground infrastructure such as fire hydrants
- An additional service offering for LiDAR surveying companies

One of IDS' customers, CAT Surveys, has successfully combined a Stream EM system with a Topcon IPS2 LiDAR system. The City of Hull and the City of Hereford were surveyed recently in the United Kingdom and the results can be seen in Figure 7.



	
<p>On site acquisition of GPR and LiDAR</p>	<p>Export of LiDAR and GPR to AutoCad</p>
	
<p>IPS2 camera with GPR under road</p>	<p>IP65 rating</p>

Figure 7 shows the Stream EM and IPS2 being used for coordinated capture of above and below ground assets by CAT Surveys. It also shows some of CAT Surveys client deliverables.

5. CENTRALISED AND COORDINATED MANAGEMENT OF BELOW GROUND ASSETS

A major problem facing governments around the world in large cities is traffic congestion. One of the main advantages of having an accurate centralised database of underground assets is that works to excavate these can become more efficient and effective by allowing the use of other less intrusive technologies such as trenchless technologies which permit the emplacement of underground assets without digging large holes in the ground.

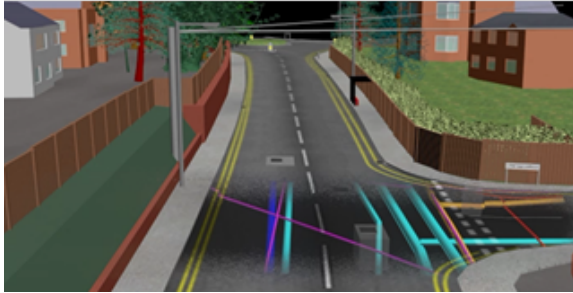
One possible framework for this in Australia, outlined in Figure 8, would include GPR, EMI (electromagnetic induction), vacuum excavation and existing Dial Before You Dig plans and be managed following the Australian SUI standard. Government and asset owners would verify data by only contracting utility locating service provider and surveyors which follow the Australian SUI standards to ensure that the data is maintained to accepted and defined levels of accuracy. The asset owners and government, being shareholders of the data, would then release utility information for a fee bundled into all new excavation and construction permits issued, thereby helping it become a profitable entity.

The centralised system would require clearly defined standards methods and procedures and have the strong support of the utility locating and surveying industry, asset owners and government and be verified by accredited utility locators. The system would need to be well organised and have effective administration, have a high quality assurance of data and an effective feedback loop in operation. This framework is a variation of a framework tailored for the Australian market and suggested as a solution in Hong Kong from UtilityINFO Limited by King Wong and seen in a paper by Spencer Li (Li, 2010). The use of array radar systems would greatly assist in delivering data rapidly for this type of database.

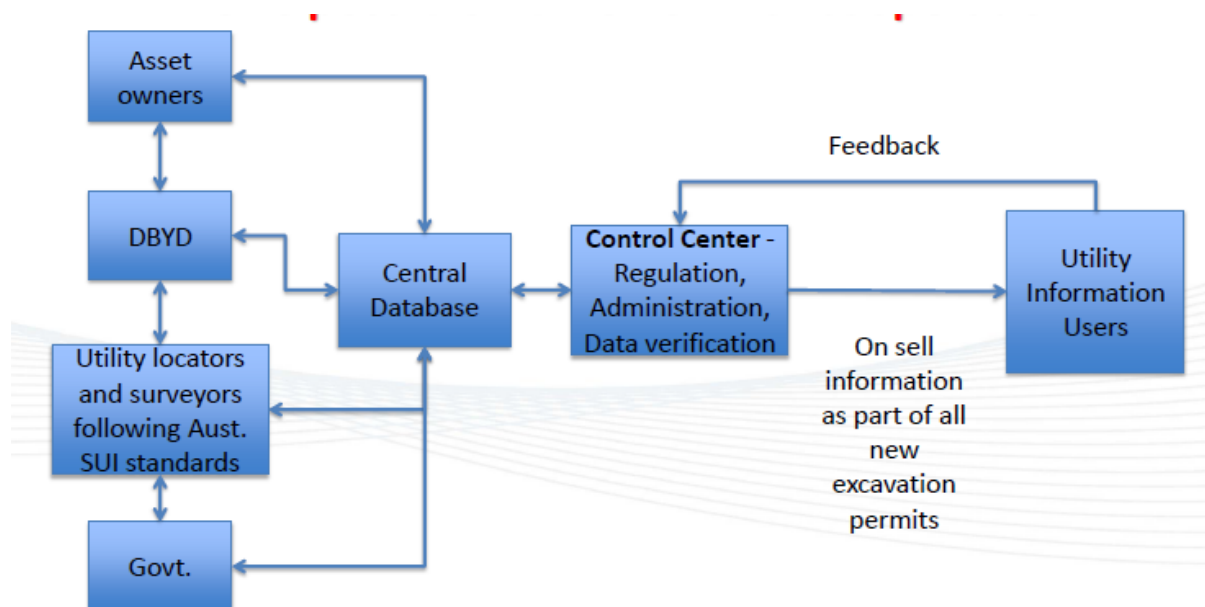

Figure 8 shows a possible framework for a centralised database of utilities available to the public

6. CONCLUSION

Ground Penetrating Radar has been a tool used extensively in the utility locating industry for several decades. In Australia, until recently, many different utility locating companies, each with varying skill levels methods and procedures operated in an unregulated environment. The information, in the most part, has been lost or is kept on file by the individual companies, and there still remains no centralised underground asset database.

The arrival of more advanced array GPR systems and software available to process and interpret datasets, has exponentially increased the ability to collect and provide accurate deliverables for large areas very rapidly. Concurrent advances in the accuracy and availability of relatively cheap LiDAR solutions to capture above ground asset information, has also attracted the interest of many and there is now a race on to capture this information globally.

This being the case, in a society where information is key, perhaps now is the time to capture above and below ground datasets concurrently, and make this information available so that it can be accessed as required to facilitate new construction projects.

REFERENCES

- Daniels, J.J., 2000, Ground Penetrating Radar Fundamentals, pp 1-21, Ohio, Department of Geological Sciences, The Ohio State University Prepared as an appendix to a report to the U.S.EPA, Region V Nov. 25, 2000
- Fernando R., 2014, Personal Communication, Senior Business Development Manager HERE, GeoNext 2014 Conference, Sydney
- Committee IT-036, 2013, AS 5488-2013_V2 Classification of Subsurface Utility Information., pp1-22, Canberra, Council of Standards Australia
- Li, S.,2010, GIS Applications on Environmental Protection – Utilities “Integrated Data Management System” in Hong Kong, pp 1-11, Hong Kong, UtilityINFO Limited.
- Manacorda G., Simi A. and Miniati M., 2009, Mapping underground assets with fully innovative GPR hardware and software tools, pp 1-9, Ontario, The North American Society (NASTT) and the International Society for Trenchless Technology (ISTT) International No-Dig show 2009
- Simi A., Manacorda G., Bracciali S. and Buonaccorsi A., 2010, Underground asset mapping with dual-frequency dual-polarized GPR massive array, pp 1-5, Lecce, GPR 2010.

BIOGRAPHICAL NOTES

Mark graduated as a Geophysicist from the University of Adelaide in 1998, has 14 years' experience specializing in ground penetrating radar and is Business Development Manager for leading radar manufacturer IDS Australasia (Ingegneria Dei Sistemi S.p.A). Mark's work in the past has focused on the integration of radar technology with other equipment such as linescan cameras, ultrasonics, accelerometers, LiDAR, EM, FWD, and MASW for large scale infrastructure monitoring and maintenance optimization.

CONTACTS

Mark Bell
IDS (Ingegneria Dei Sistemi) Australasia
Unit 5, 3-5 Hinkler Court, Brendale, 4500
Brisbane
AUSTRALIA
Tel: +61 732055524
Fax: +61 732055536
m.bell@idscorporation.com
www.idscorporation.com